

TECHNICAL DATA | 45° ELBOW LONG SDR17

Standards:	AS/NZS 4129 SDR17
Size Range:	63mm - 400mm
Materials:	Polyethylene (PE) 100
Pressure Rating:	PN10, Water 5 BAR, Gas
Fitting Details:	Injected

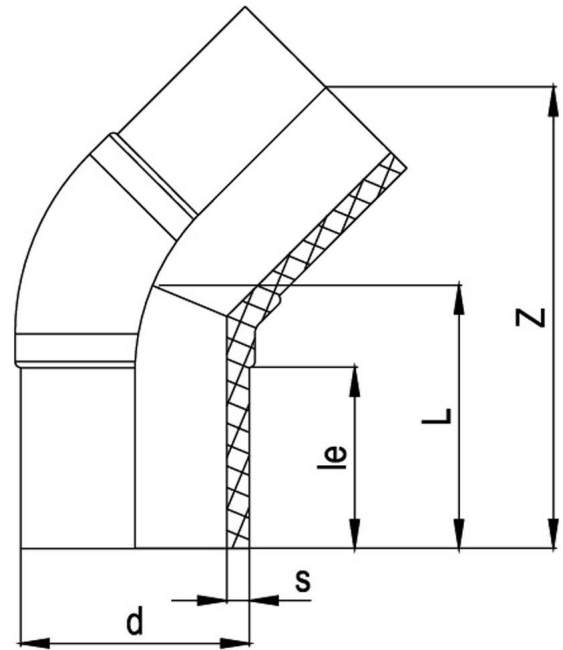

d mm	le mm	Z mm	s mm	Weight kg	Code
63	64	160	3.8	0.180	BWEL174563
75	72	176	4.5	0.250	BWEL174575
90	83	202	5.4	0.440	BWEL174590
110	87	220	6.6	0.700	BWEL1745110
125	92	239	7.4	0.930	BWEL1745125
140	97	250	8.3	1.245	BWEL1745140
160	103	273	9.5	1.785	BWEL1745160
180	110	290	10.7	2.380	BWEL1745180
200	117	311	11.9	3.360	BWEL1745200
225	122	341	13.4	4.370	BWEL1745225
250	135	368	14.8	5.880	BWEL1745250
280	146	406	16.6	8.200	BWEL145280
315	158	430	18.7	11.115	BWEL1745315
355	173	490	21.1	16.150	BWEL1745355
400	189	548	23.7	23.000	BWEL1745400



Note:

Installation should always be performed by a licensed operator. It is the responsibility of the installer to check that both the pipe(s) and fitting(s) that are installed are compatible, only compatible materials should be joined together. It is the responsibility of the licensed installer to check the PN and SDR ratings marked on the fitting(s) and ensure that the pipe is compatible. Correct installation procedures should always be followed.

The drawings, materials and specifications outlined are subject to change without notice due to the continuous improvements and development of our product range.

FUSION QLD PTY LTD

ABN: 42 987 067 369
13 Vision Court, Noosaville, QLD, 4566
42-44 South Link, Dandenong, VIC, 3175

CONTACT

T: +61 7 5474 3000 (Qld)
T: +61 3 9037 4755 (Vic)
E: sales@fusionqld.com.au
W: fusionqld.com.au